



Aeris Swopper

- Product information
- Product dimensions
- Tender text
- TÜV-GS certificate
- LGA pollutant test certificate
- Care instructions
- Fabric sample overview

Aeris Swopper Product information



Product information

Any more active and it would no longer be sitting.



Aeris Swopper Product information

Aeris Swopper

The Aeris Swopper is the pioneer among active chairs. As the first office chair with three-dimensional movement, it has revolutionised the way people work. Its innovative technology automatically keeps the sitter in motion, which strengthens the back. This is not only fun and energising, but also effectively prevents back pain. The wide base and the joint close to the floor ensure a secure hold and 360° mobility. Its striking design makes the Aeris Swopper an absolute eye-catcher in modern office spaces.



Product information



Aeris 3D technology enables movement in all three dimensions: forwards, to the sides, backwards and - unique to Aeris - upwards and downwards. The so-called vertical swinging relieves the intervertebral discs, makes it easier to stand up, promotes blood circulation and gets the circulation going. The convex moulded seat also promotes an upright posture and prevents the seat edges from pinching.

Aeris Swopper Product information

Aeris Swopper

Technical Data:

Product weight
11 kg without backrest, 17 kg with backrest

Footring
Die-cast aluminium, powder coated,
diameter: 55 cm without castors, 58 cm with
castors

max. user weight
120 kg

Seat
Seat support: plastic, upholstery: PU
foam,diameter: 43 cm

Castor types
Soft floor castors, hard floor castors according
to DIN EN 12529

Swopper Air
Breathable, pressure-regulating high-tech
cushioning with five functional layers

Swopper Work
Swopper plus backrest including castors
fulfilling DIN EN 1335

Product information

How to choose the right spring:

Light
Body weight under 50 kg

Standard
This spring suits almost everyone

High
Height over 185 cm

Low
Table is lower than 65 cm

Awards and Certifications:



Aeris Swopper Product dimensions

Aeris Swopper

Dimensions

Overall height
52 cm - 66 cm (unloaded)

Overall depth
59 cm

Overall width
59 cm

Seat height - Standard
45 cm - 59 cm (loaded)

Seat width
41 cm

Seat depth
41 cm

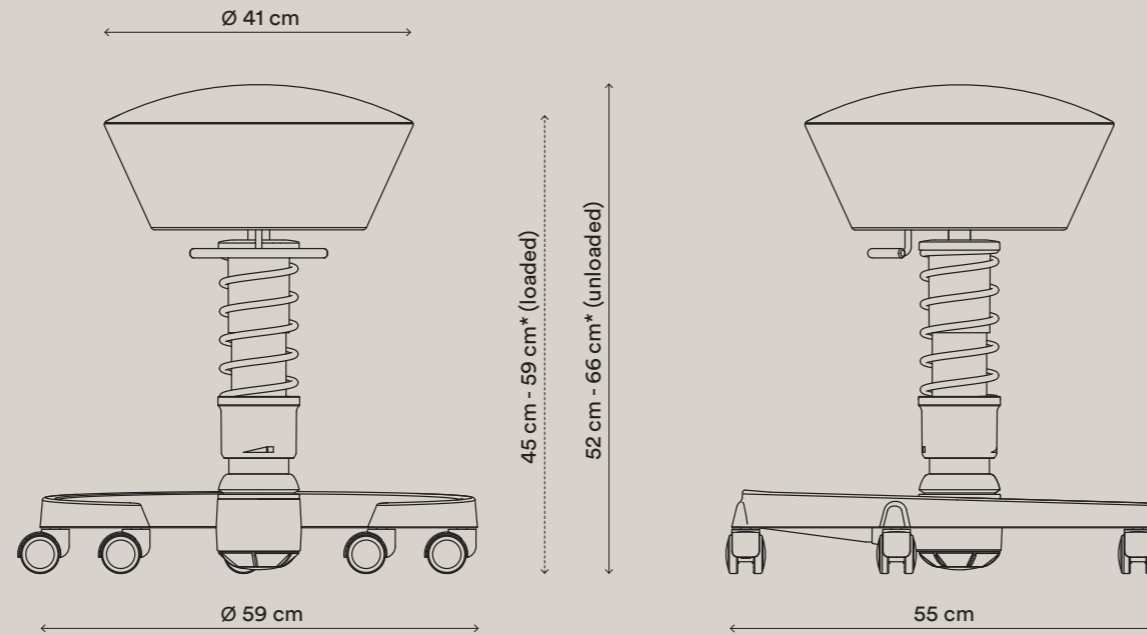

Product dimensions

Spring strut type

Low
Seat height loaded 42 cm - 56 cm,
Overall height unloaded 50 cm - 64 cm

Standard*
Seat height loaded 45 cm - 59 cm,
Overall height unloaded 52 cm - 66 cm

High
Seat height loaded 49 cm - 69 cm,
Overall height unloaded 56 cm - 76 cm

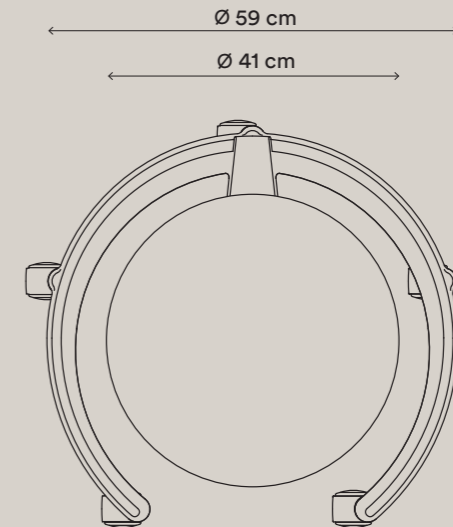

Aeris Swopper Product dimensions

Aeris Swopper

Dimensions

Overall height
52 cm - 66 cm (unloaded)

Overall depth
55 cm

Overall width
55 cm

Seat height - Standard
45 cm - 59 cm (loaded)

Seat width
41 cm

Seat depth
41 cm

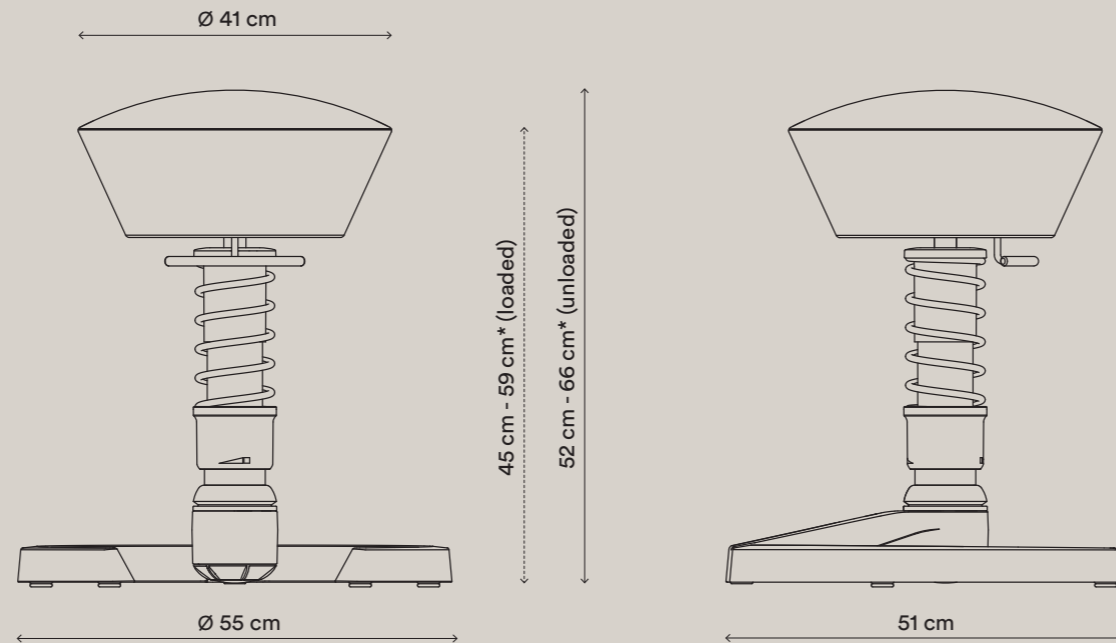

Product dimensions

Spring strut type

Low
Seat height loaded 42 cm - 56 cm,
Overall height unloaded 50 cm - 64 cm

Standard*
Seat height loaded 45 cm - 59 cm,
Overall height unloaded 52 cm - 66 cm

High
Seat height loaded 49 cm - 69 cm,
Overall height unloaded 56 cm - 76 cm

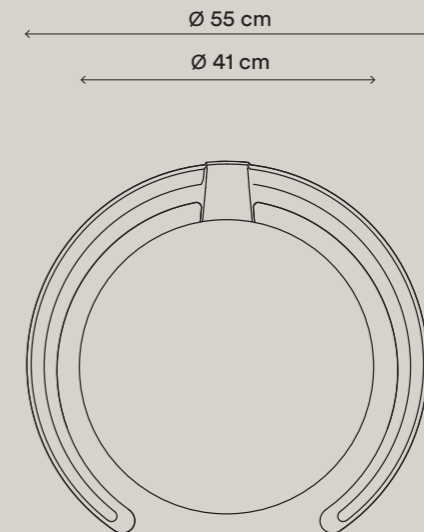

Aeris Swopper Tender text

Aeris Swopper

Product type

3D active office swivel chair,
without backrest



Tender text





Produktbeschreibung

The Aeris Swopper is an ergonomic chair with innovative 3D technology. This technology allows the chair to swing vertically to all sides. The lateral flexibility extends the reach and ensures an optimum posture in relation to the work surface. This keeps muscles, intervertebral discs, tendons and joints fit. Vertical swaying relieves pressure on the intervertebral discs, makes it easier to stand up, promotes blood circulation and gets the circulation going. The Aeris Swopper has a convex seat, which promotes an upright posture and blood circulation, and avoids pressing seat edges. The stable foot ring is extremely tilt-resistant and stable, available with or without castors. The vertical swing can be adjusted to all users from 50 - 120 kg (standard suspension leg) and 35 - 50 kg (light suspension leg), and the horizontal flexibility can also be adjusted in terms of resistance. The seat can be rotated through 360°, allowing the user to sit down from any direction.

Aeris Swopper TÜV-GS certificate

Aeris Swopper

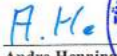
TÜV-GS certificate Standard

Zertifikat		Certificate		 TÜVRheinland®	
Zertifikat Nr.	Certificate No.	Blatt	Page		
R 60112562		0001			
Ihr Zeichen	Client Reference	Unser Zeichen	Our Reference	Ausstellungsdatum	Date of Issue
		0010--21255148	001	03.08.2016	(day/mo/yr)
Genehmigungsinhaber			Fertigungsstätte		
License Holder aeris GmbH Hans-Stießberger-Str. 2 a // 3. OG 85540 Haar Deutschland			Manufacturing Plant aeris GmbH Von-Holzapfel-Str. 6 86497 Horgau Deutschland		
Prüfzeichen			Geprüft nach		
 Bauart geprüft Sicherheit Regelmäßige Produktions- überwachung www.tuv.com ID: 111210235			Tested acc. to ANSI/BIFMA X5.1-2011		
Zertifiziertes Produkt (Geräteidentifikation)				Lizenzentgelte - Einheit	
Certified Product (Product Identification)				License Fee - Unit	
<u>Bürostuhl</u>					
Modell: swopper				5	
Bestehend aus:					
- Fußring mit Gleitern oder optional mit 5 lastabhängig gebremsten Lenkdoppelrollen, Bezeichnung der Rollen: MOVE 50-36 - Federbein mit Gasdruckfeder - Sitz gepolstert und mit Stoff überzogen					
Einstellmöglichkeiten:					
- Höhe der Sitzfläche mittels Gasfeder von KGS; Bezeichnung der Gasfeder: KGL DIN 4550-3 - Einstellung der seitlichen Flexibilität - Einstellung der vertikalen Federung					
Abmessungen (H x B x T): 698 mm x 569 mm x 530 mm, 10,55 kg					
5					
Dem Zertifikat liegt unsere Prüf- und Zertifizierungsordnung zugrunde und es bestätigt die Konformität des Produktes mit den oben genannten Standards und Prüfgrundlagen. Zusätzliche Anforderungen in Ländern, in denen das Produkt in Verkehr gebracht werden soll, müssen zusätzlich betrachtet werden. Die Herstellung des zertifizierten Produktes wird überwacht. This certificate is based on our Testing and Certification Regulation and states the conformity of the product with the standards and testing requirements as indicated above. Any additional requirements in countries where the product is going to be marketed have to be considered additionally. The manufacturing of the certified product is subject to surveillance.					
TÜV Rheinland LGA Products GmbH, Tillystraße 2, 90431 Nürnberg Tel.: +49 221 806-1371 e-mail: cert-validity@de.tuv.com Fax: +49 221 806-3935 http://www.tuv.com/safety				Zertifizierungsstelle  Andre Henning 	

Aeris Swopper TÜV-GS certificate

Aeris Swopper

TÜV-GS certificate

Zertifikat		Certificate		 TÜVRheinland®	
Zertifikat Nr. / Certificate No.	S 60151431	Blatt / Sheet	0001		
Ihr Zeichen / Client Reference	0010--60408688 001	Unser Zeichen / Our Reference	0010--60408688 001	Längstens gültig bis / Latest expiration date (day/mo/yr)	09.09.2025
Genehmigungsinhaber / License Holder		Fertigungsstätte / Manufacturing Plant			
aeris GmbH Hans-Stießberger-Str. 2 a // 3. OG 85540 Haar Deutschland		aeris GmbH Von-Holzappel-Str. 6 86497 Horgau Deutschland			
Prüfzeichen / Test Mark		Geprüft nach / Tested acc. to			
 		DIN EN 16139/03.14			
Zertifiziertes Produkt (Geräteidentifikation) / Certified Product (Product Identification)			Lizenzentgelte - Einheit / License Fee - Unit		
Hocker			2		
Modelle „Swopper“ und „Swopper high“ Sitzhöhe verstellbar mit Hebel durch Gasfeder von Stabilus; Bezeichnung der Gasfeder STAB-O-MAT DIN 1695E 4d Einstellung der Federkraft und Härtegrad der Federung durch Ringfeder unterhalb der Sitzfläche. Einstellung der seitlichen Auslenkung der Sitzfläche mittels Handrad unterhalb des ringförmigen Fußgestells. Gewichtsableitung auf den Fußboden, durch die Belastung des Sitzes mittels Gasfeder Sitz gepolstert und mit Stoff bezogen. Modell swopper high mit 5 lastabhängig gebremsten Lenkdoppelrolle oder Gleitern; Modell swopper high mit Gleitern Abmessungen: (H x B x T): Modell swopper: 470mm - 600mm x 560mm x 560mm; 10,45 kg Modell swopper high: 780mm - 590mm x 560mm x 560mm; 10,05 kg Alle sicherheitsrelevanten Anforderungen der DIN EN 16139 /03.14 Belastungsstufe 1 sind erfüllt. Ersetzt S 60;02731. Parent ID: 0000043485.					
Dem Zertifikat liegt unsere Prüf- und Zertifizierungsordnung zugrunde. Produkt und Fertigungsstätte erfüllen § 20 und § 21 des Produktsicherheitsgesetzes. This certificate is based on our Testing and Certification Regulation Product and production fulfill par § 20 and § 21 of the Product Safety Law.					
TÜV Rheinland LGA Products GmbH, Tillystraße 2, 90431 Nürnberg Tel: +49 221 806-1371 e-mail: cert-validity@de.tuv.com Fax: +49 221 806-3935 http://www.tuv.com/safety					
Ausstellungsdatum / Date of Issue : 10.09.2020 (day/mo/yr)				Zertifizierungsstelle	
				 C. Prosch	

Aeris Swopper LGA pollutant test certificate

Aeris Swopper

LGA pollutant test certificate

Zertifikat

Certificate



Zertifikat Nr. Certificate No.
TX 60156618

Blatt Blatt
0001

Ihr Zeichen Client Reference

Unser Zeichen Our Reference
0010--60442052 001

Längstens gültig bis Latest expiration date
01.09.2026 (day/mo/yr)

Genehmigungsinhaber License Holder

aeris GmbH
Hans-Stießberger-Str. 2 a // 3. OG
85540 Haar
Deutschland

Fertigungsstätte Manufacturing Plant

aeris GmbH
Von-Holzappel-Str. 6
86497 Horgau
Deutschland

Prüfzeichen Test Mark



Geprüft nach Tested acc. to

2 PFG S 0121/02.19 Schadstoffprüfung gemäß Kriterienkatalog "TÜV Rheinland certified", Produktgruppe "Sitz- und Liegemöbel"

Zertifiziertes Produkt (Geräteidentifikation)
Certified Product (Product Identification)

Stuhl / Bürostuhl / Hocker / Stehhilfe / Kinderstuhl

3D-Aktiv-Bürodrehstuhl: Swopper / Swopper mit Lehne (WORK)
Fußring (Aluminiumdruckguss, pulverbeschichtet) mit Rollen,
Federbein mit Gasdruckfeder, Sitzträger aus Kunststoff mit
PU-Formschaumpolsterung und Stoffbezug; Swopper WORK mit
Rückenlehne aus Kunststoff am Fußring montiert optional mit
Stoffbezug.

Aktiv-Steh-Sitz: Muvman / Muvman Industry
Fußsteller aus Kunststoff, glasfaserverstärkt, Mittelsäule
mit Gasdruckfeder, Sitzträger aus Kunststoff mit PU-Schaum
gepolstert und Stoffbezug; Muvman Industry Standfuß aus
Aluminiumdruckguss, pulverbeschichtet schwarz mit
Universalgleitern, Sitz mit Integralschaum in schwarz.

Aktiv-Kinder-Drehstuhl: Swoppster
Fußring (Kunststoff, glasfaserverstärkt) mit
Rollen/Standfüßen, Federbein mit Gasdruckfeder, Sitzträger
aus Kunststoff mit PU-Schaumpolsterung und Stoffbezug.

Ausgewählte textile Bezugsstoffe der aeris Kollektion.

Dem Zertifikat liegt unsere Prüf- und Zertifizierungsordnung zugrunde.

Zertifizierungsstelle

TÜV Rheinland LGA Products GmbH, Tillystraße 2, 90431 Nürnberg
Tel.: +49 221 806-1371 e-mail: cert-validity@de.tuv.com
Fax: +49 221 806-3935 http://www.tuv.com/safety



Dr. J. Galinkina

Ausstellungsdatum Date of Issue : 02.09.2021 (day/mo/yr)

Microfibre cover

Optimum care is ensured by using water and pH neutral soapsuds. Stains containing oil and fat should be treated beforehand with ethyl alcohol.

After each cleaning action you should rinse with clear water. Never use chlorinated detergents.

The seat must only be treated damp, not wet, otherwise the materials used under the fabric may be damaged. Therefore, please use only a little bit of water and apply only small amounts of the cleaning detergents.

To avoid edges, please always treat from the edge to the middle.

Wool blend cover

The cover should ideally only be vacuumed gently at regular intervals using a soft vacuum nozzle. Always remove stains as quickly as possible.

Most types of stains can be easily removed with lukewarm water, possibly with the addition of a pH-neutral cleaning agent. Always use a clean, white cotton cloth for this.

Please press a dry kitchen towel or colorless kitchen paper against the fabric so that moisture and dirt can be absorbed.

Mesh fabric cover (Air: multi-layer construction)

Most types of stains can be easily removed with lukewarm water, possibly with the addition of a pH-neutral detergent. Always use a clean, white cotton cloth for this.

Treat with clear water after each cleaning. Never use cleaning agents containing chlorine.

The seat may only be treated when damp, not wet, as otherwise the upholstery under the fabric may be damaged. Therefore, please only use a small amount of water and only use small amounts of cleaning agent.

Artificial leather Stamskin cover

The cover should only be carefully rubbed with a brush and lukewarm water.

If necessary, use soapy water, then wipe off with clean water and a cloth.

The seat may only be treated with a damp, not wet, cloth as otherwise the upholstery under the fabric may be damaged. Therefore, please use only a little water and only apply small amounts of cleaning agent.

Attention: Leather care products, stain remover, solvents or disinfectants must not be used.

Aeris Swopper Care instructions

Aeris Swopper

Artificial leather Uruguay cover

Wipe with a damp cloth, if necessary use a liquid cleaning agent containing 50 % water and 50 % alcohol.

Felt cover

As a genuine natural product made from 90% wool and with a stain-resistant structure, the cover should ideally be vacuumed regularly using a soft vacuum nozzle only.

Care instructions

Leder-Bezug

Wipe with a soft, damp cloth without detergent, then rub over a large area with a clean cloth.

If necessary, treat with leather care product.

Cleaning the foot ring

The best way to remove scuff marks from shoe soles is with a soft eraser or a soft cloth with white spirit.

Aeris Swopper Fabric sample overview

Aeris Swopper

Fabric sample overview

Capture / Gabriel



CP01, black melange
5501

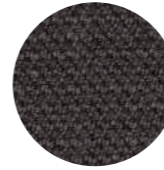

CPU02, grey melange
4101

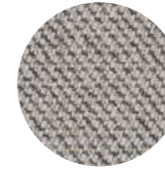

CP03, red melange
5401



CP04, blue melange
4901

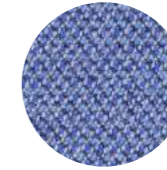

CP05, green melange
5301

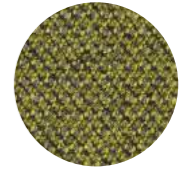

CP21, brown grey
melange
04201

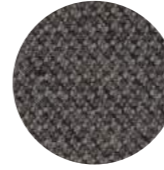

CP22, stone grey
melange
04102

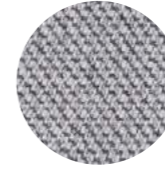

CP23, platinum grey
melange
04001

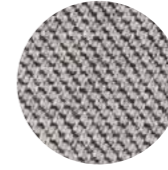

CP24, slate grey
melange
04601

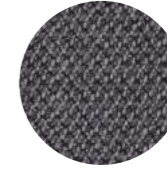

CP25, black-blue
melange
05201



CP26, pigeon blue
melange
04902

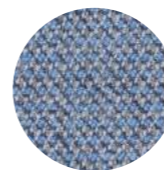

CP27, azure blue
melange
05002

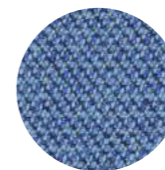

CP28, petrol blue
melange
05001

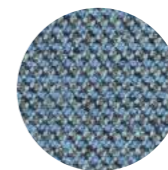

CP29, dark red
melange
05402

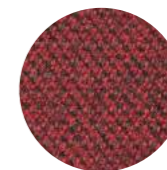

CP30, orange-red
melange
04301



CP31, pink-red
melange
04802



CP32, pink-violet
melange
04801



CP33, pink-beige
melange
04803

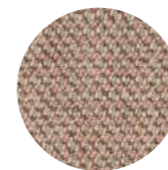

CP34, beige-green
melange
05102

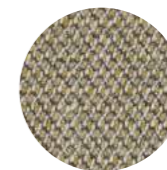

CP35, green-beige
melange
05101

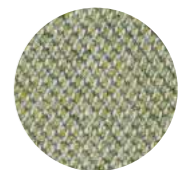

Aeris Swopper Fabric sample overview

Aeris Swopper

Fabric sample overview

Select / Gabriel

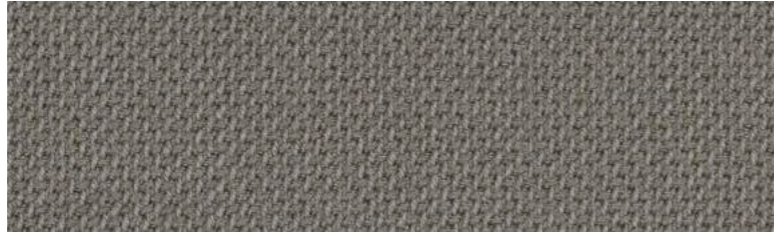

SE01, black
60999



SE02, grey
60130

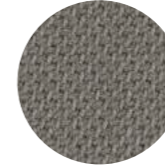

SE03, red
64089

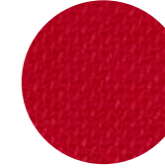

SE04, blue
66071

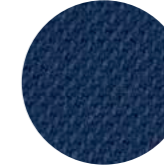

SE05, green
67095

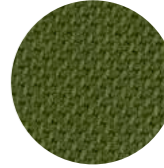

SE06, black grey
60051

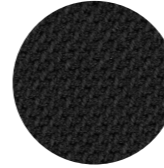

SE07, slate grey
60134

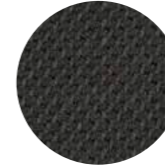

SE08, blue grey
60133

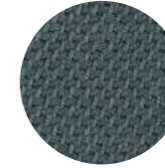

SE09, stone grey
60129

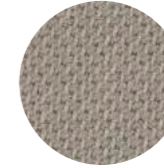

SE10, pastel blue
67098

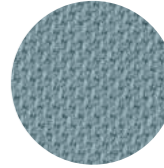

SE11, azure blue
66192

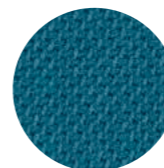

SE12, grey blue
67097

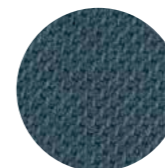

SE13, steel blue
66193

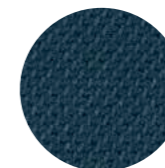

SE14, coral red
64216

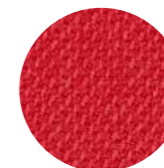

SE15, pale pink
65117

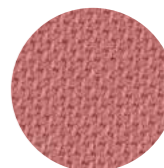

SE16, aubergine
61186



SE17, dark olive
68209

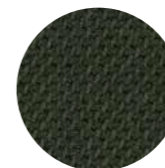

SE18, pastel green
68210

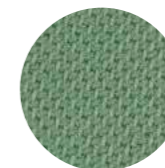

SE19, turquoise
67100

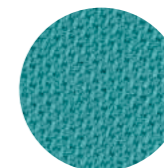

SE20, pastel turquoise
67101

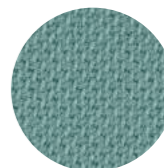

Aeris Swopper Fabric sample overview

Aeris Swopper

Fabric sample overview

Comfort / Gabriel



CM01, black
0050



CM02, grey
1012

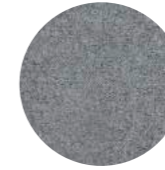

CM03, red
1414

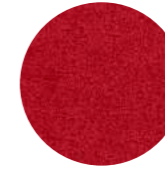

CM04, blue
66004

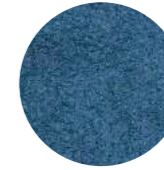

CM05, green
8397

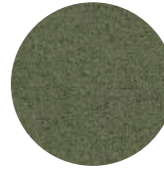

Runner / Gabriel

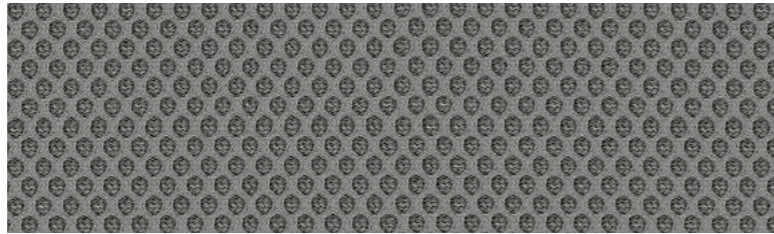

RN01, black
60999

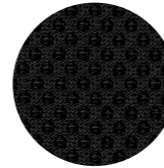

RN02, grey
60011

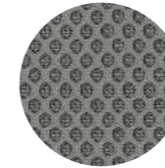

RN03, red
64119

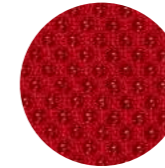

RN04, blue
66123

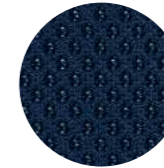

RN05, green
68110

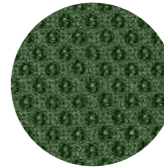

Luna / Gabriel



LU01, dark grey
melange
4012

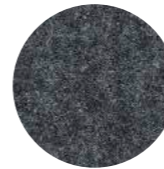

LU02, light grey
melange
4013

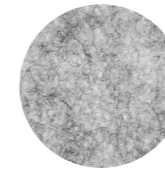

Atlantic / Heller-Leder

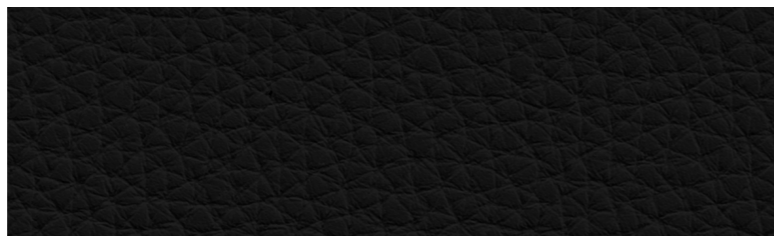

LA01, black
35002 999

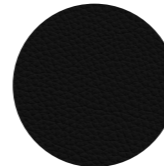

Aeris Swopper Fabric sample overview

Aeris Swopper

Fabric sample overview

Uruguay / Elastron



UR01, black
13-901

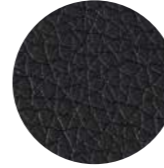

Stamskin / Serge Ferrari



ST00, white
10120



Gabriel Capture features

The use of lightly felted, multicolored wool in this material gives it a unique and appealing texture. The sophisticated melange pattern creates a fascinating look that immediately catches the eye. But not just visually, the feel of this material is also impressive across the board. The wool is incredibly soft and comfortable, which guarantees a pleasant and cozy sitting or reclining experience.

The outstanding wear resistance of this material guarantees a long service life and maintains its aesthetics even with regular use and stress. This makes it a durable choice that can withstand the high demands of daily use.

Finally, the Capture wool cover meets the demanding requirements of the furniture industry, which further underlines its quality and performance. It is therefore a reliable option that meets the standards of the furniture industry.

Capture-Specifications

Design no.	2472		
Composition	85% New Zealand wool / 15% polyamide		
Weight	g/lm 475 oz/lin.yd 15.32		
Width	cm 140 inches 55		
Abrasion	rubs martindale (EN ISO 12947-2) 200.000 rubs martindale (ASTM D4966) (heavy duty upholstery) 200.000 ASTM D4966 Martindale (heavy duty) pass Abrasion test results exceeding ACT Performance Guidelines are not an indicator of product lifespan		
Pilling	scale 1-5, max. 5 - EN ISO 12945-2 ASTM D4970 Pilling	pass	4-5
Light fastness	scale 1-8, max. 8 - EN ISO 105-B02 AATCC 16 Light fastness	pass	5-7
Rubbing fastness	scale 1-5, max. 5 - EN ISO 105x12 (dry/wet)		4-5/4-5
Care instructions	dry cleaning P(S) 		
Flammability	BS EN 1021 1&2 Cigarette and Match BS 5852 Part 1 O,1 Cigarette & Match, The Furniture and Furnishing Regulations 1988 Class Uno UNI 9175 Class 1 I EMME CA TB 117-2013 ASTM E 84 Class 1 Will also pass other flammability standards. Flame retardant performance is dependent upon the foam used. Contains no flame retardant chemicals.		
Environment	OEKO-TEX® STANDARD 100 EU Ecolabel		

Gabriel Select features

This impressive material boasts an elegant simplicity that is accompanied by an allround user-friendly design. With an extensive full spectrum color palette, it offers an almost endless variety of possibilities for design, making it fits perfectly with a wide variety of furnishing styles.

Thanks to its superior abrasion resistance, measured by an impressive 200,000 Martindale cycles, this material is extremely durable and resistant, even in heavy-duty environments. It is therefore an ideal choice for Highly frequented rooms such as public areas, offices or restaurants that require a durable solution.

The environmental friendliness of these materials is confirmed by the EU Ecolabel, which makes its production sustainable and environmentally friendly. It also fulfills the STANDARD 100 of OEKO-TEX®, which means that it has been tested for possible harmful substances is considered safe for human use.

Select-Specifications

Design no.	2498		
Composition	85% New Zealand wool / 15% polyamide		
Weight	g/lm 510 oz/lin.yd 16.45		
Width	cm 140 inches 55		
Abrasion	rubs martindale (EN ISO 12947-2) 200.000 ASTM D4966 Martindale (heavy duty) rubs martindale (ASTM D4966) (heavy duty upholstery) 100.000 Abrasion test results exceeding ACT Performance Guidelines are not an indicator of product lifespan		
Pilling	scale 1-5, max. 5 - EN ISO 12945-2 ASTM D4970 Pilling	pass	4
Light fastness	scale 1-8, max. 8 - EN ISO 105-B02 AATCC 16 Light fastness	pass	5-8
Rubbing fastness	scale 1-5, max. 5 - EN ISO 105x12 (dry/wet) AATCC 8 or 116 Dry/wet crocking		4-5/4-5 pass
Care instructions	dry cleaning P(S) 		
Flammability	BS EN 1021-1 Cigarette BS EN 1021-2 Match BS 5852 Part 1 O,1 Cigarette & Match, The Furniture and Furnishing Regulations 1988 BS 5852 Crib 5 IMO MSC 307(88) Annex 1 part 8 MED Certificate IMO IMO MSC 307(88) Annex 1 part 8 UK MED Certificate IMO UK CA TB 117-2013 Will also pass other flammability standards. Flame retardant performance is dependent upon the foam used. Contains no flame retardant chemicals..		
Environment	OEKO-TEX® STANDARD 100 EU Ecolabel		

Gabriel Comfort features

The high-quality fabric was specially developed for intensive use and has outstanding properties. With an impressive Martindale value of 150,000, it is extremely hard-wearing and resistant to abrasion.

Thanks to the use of carbon fibers, the fabric is permanently antistatic, which means that it hardly collects any dust and is therefore particularly easy to clean. Furthermore it is dirt-repellent and water and oil repellent, making it extremely resistant to soiling.

Another plus is its openness to diffusion, which means that the fabric enables excellent air and moisture exchange and thus counteracts the formation of mold.



Safety is a top priority with this fabric, as it is permanently fire-resistant - a property achieved by fire-retardant fibers. It therefore offers a high level of safety and protection.

For the environmentally conscious buyer, it is important to know that this fabric contains 37% recycled fibers, which contributes to the sustainable use of resources.

And to top it all off, the fabric manufacturer offers a generous 10-year guarantee against abrasion and pilling, which further reinforces confidence in the quality of this product.

The fabric also meets the requirements of the renowned STANDARD 100 by OEKO-TEX®, which means that it has been tested for harmful substances and is considered safe for human use.

Comfort-Specifications

Design no.	8580
Composition	51% polyester/37% post-consumer rec.pes./ 12% polyurethane incl. antistatic fibers and fire retardant fibers in the backside
Weight	g/lm 385 oz/lin.yd 12.42
Width	cm 140 inches 55
Abrasion	rubs martindale (EN ISO 12947-2) 150.000 Abrasion test results exceeding ACT Performance Guidelines are not an indicator of product lifespan
Pilling	scale 1-5, max. 5 - EN ISO 12945-2 5
Light fastness	scale 1-8, max. 8 - EN ISO 105-B02 5-7
Rubbing fastness	scale 1-5, max. 5 - EN ISO 105×12 (dry/wet) 4/4-5
Care instructions	wash or dry cleaning P(W) most stains can be removed by brushing with a suede brush or using an eraser. or use a solution of luke-warm water and a neutral detergent. 74°C shrinkage max. 2,5%.  60°C shrinkage max. 2%. 
Flammability	BS EN 1021 1&2 Cigarette and Match BS EN 1021-1 Cigarette ÖNORM A3800-B2-B3825-Q1 UK NF P 92-503 M3 CA TB 117-2013 Will also pass other flammability standards. Flame retardant performance is dependent upon the foam used.
Environment	OEKO-TEX® STANDARD 100

Gabriel Runner features

The Gabriel Runner fabric not only gives seating furniture an inviting and fascinating surface, but its colour palette also opens up a wide range of possible uses in the working environment and at home. Its design exudes comfort, elegance and robustness and can be perfectly combined with other Gabriel fabrics. 100% made from recyclable polyester, including 20% post-consumer recycled polyester, this fabric not only fulfils the demanding furniture facts requirements, but also proudly bears the EU Ecolabel and STANDARD 100 certification from OEKO-TEX®.

Runner-Specifications

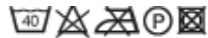
Design no.	8705
Composition	80% polyester / 20% post-consumer recycled polyester
Weight	g/lm 510 oz/lin.yd 16.45
Width	cm 160 inches 63
Abrasion	rubs martindale (EN ISO 12947-2) 70,000 double rubs wyzenbeek (ASTM D4157) (heavy duty upholstery)100,000 ASTM D4157-07 Wyz abrasion (heavy duty)pass Abrasion test results exceeding ACT Performance Guidelines are not an indicator of product lifespan
Pilling	scale 1-5, max. 5 - EN ISO 12945-2 5 ASTM D3511 Pilling pass
Light fastness	scale 1-8, max. 8 - EN ISO 105-B025-7 AATCC 16 Lichtechtheit pass
Rubbing fastness	scale 1-5, max. 5 - EN ISO 105×12 (dry/wet) 4-5/4-5 AATCC 8 oder 116 Nass-/Troocken-Crocking pass
Care instructions	wash or dry cleaning P(W). Runner is made of polyester which is a material suited for environments with special requirements for cleaning.  40°C shrinkage max. 5%.
Flammability	CA TB 117-2013 BS EN 1021-1 Cigarette BS EN 1021 1&2 Cigarette and Match Will also pass other flammability standards. Flame retardant performance is dependent upon the foam used. Contains no flame retardant chemicals.
Environment	OEKO-TEX® STANDARD 100 EU Ecolabel Cradle to Cradle Certified® Bronze

Gabriel Luna features

If you are looking for a fabric that creates a very cosy atmosphere, then Luna is the perfect choice. This environmentally friendly material is characterised by its remarkable abrasion resistance and promises long-lasting pleasure with your seating furniture.

A special feature of the Luna upholstery fabric is its ability to make stains and dirt virtually invisible, making it an excellent option for all households with children or pets. You no longer have to worry about unsightly stains spoiling your seat cover.

The fabric also fulfils important environmental standards, such as the EU Ecolabel and the STANDARD 100 by OEKO-TEX®, which means that it has been tested for harmful substances and found to be harmless.

Luna also fulfils the Möbelfakta requirements, which underlines its quality and durability.

Luna-Specifications

Design no.	2393
Composition	90% New Zealand wool / 10% polyamide
Weight	g/lm 680 oz/lin.yd 21,93
Width	cm 140 inches 55
Abrasion	rubs martindale (EN ISO 12947-2) 70.000 rubs martindale (ASTM D4966-02) (heavy duty upholstery) 100.000 ASTM D4966 Martindale (heavy duty) pass Abrasion test results exceeding ACT Performance Guidelines are not an indicator of product lifespan
Pilling	scale 1-5, max. 5 - EN ISO 12945-2 3-4 ASTM D3511 Pilling pass
Light fastness	scale 1-8, max. 8 - EN ISO 105-B025-6 AATCC 16 Light fastness pass
Rubbing fastness	scale 1-5, max. 5 - EN ISO 105×12 (dry/wet) 4-5/4-5 AATCC 8 oder 116 dry-/wet-Croaking pass
Care instructions	dry cleaning P(S) 
Flammability	BS EN 1021 1&2 Cigarette and Match BS 5852 Part 1 0,1 Cigarette & Match, The Furniture and Furnishing Regulations 1988 ÖNORM A3800-B2-B3825-Q1 UK CA TB 117-2013 Class Uno UNI 9175 Class 1 I EMME Will also pass other flammability standards. Flame retardant performance is dependent upon the foam used. Contains no flame retardant chemicals.
Environment	OEKO-TEX® STANDARD 100 EU Ecolabel

Elastron Uruguay features

The ideal cover for easy cleaning - the Uruguay faux leather impresses with a beautiful and even surface embossing and has a very good grip. The black faux leather cover makes this model a robust companion for many years.

Uruguay-Specifications

Composition	Upper fabric: 100 % Polyurethane Underfabric: 80 % Polyester + 20 % Cotton
Weight	g/lm 600 (+/-5%)
Thickness	1,0 mm (+/-5%)
Tensile strength	EN ISO 1421 Warp: 774 N 21,0% Weft: 618 N 24,9%
Tear growth resistance	EN ISO 4674-1 Warp: 123,6 N Weft: 91,0 N
Seam Slippage resistance	EN ISO 13936-2 Warp: Kette: 3,0 mm Weft: 3,0 mm
Abrasion Test	EN ISO 5470-2 > 100.000
Colour Fastness	EN ISO 105 - BO2
Reibechtheit	EN ISO 105 - X12 Dry 5 Wet 5
Permanent Creasing Behavior	DIN EN ISO 32100/DIN 53359 - 30.000 cycles PASS
Flammability	Fire Proof Norms BS 5852 Part 1 - Cigarette Test - PASS EN 1021-1 - Cigarette Test - PASS CA Tech. Bull. 117:2013 / NFPA 260 - Cigarette Test - PASS
Environment	OEKO-TEX® STANDARD 100 EU Ecolabel Cradle to Cradle Certified® Bronze

Aeris Swopper

Stamskin features

The special Stamskin cover material is extremely durable and easy to clean. Stamskin is antifungal and antibacterial, giving this Aeris Swopper model a particularly long service life and making it a robust companion.

Stamskin Specifications

	Technical data	Norms
Description	Multilayer composite	
Carrier	Polyamide jersey	
Width	Approx. 140 cm	
Weight	780g/m2	EN ISO 2286-2
Thickness	1,0-1,2 mm	ISO 5084
Elongation at break at 125N / 5 cm	>35% / >55%	EN ISO 1421
Tearing force	>440 N / 5 cm / >280 N / 5 cm	EN ISO 1421
Tear force	>25N / >15N	EN ISO 13937/1
Abrasion resistance	>120000	EN ISO 5470-2 Martindale
Buckling	400 000	EN ISO 7854
Mould resistance	Level 0, excellent	EN ISO 846-A
Maximum application temperatures	-20°C / +70°C	
Burning behaviour Germany	Class K1	DIN 53438/T2
Cigarette test / match test	No ignition	EN 1021.1 - 1021.2
Marine test	Compliant	IMO MSC.307 (88) (2010 FTP Code) Annex 1 part 8
Aviation test	Compliant	FAR/JAR 25-853 / 855
Quality		ISO 9001
Environment		ISO 14001

Heller-Leder Atlantic features

The ideal upholstery for the office - Atlantic leather not only impresses with its high quality and beautiful surface embossing, but also offers optimum seating comfort. The soft leather is easy to care for, breathable and is characterised by its antistatic properties.

Fabric sample overview

Atlantic-Specifications

Test	Test Method	Measurement Unit	Guaranteed
Tear strength - Single edge tear	UNI EN ISO 3377-1	N	> = 20
Colour fastness to rubbing - Dry 500 Cycles	UNI EN ISO 11640:1998	Grey Scale	> = 4
Colour fastness to rubbing - Wet 250 Cycles	UNI EN ISO 11640:1998	Grey Scale	> = 4
Colour fastness to rubbing - Sweat 80 Cycles	UNI EN ISO 11640:1998 ISO 11641 pH8	Grey Scale	> = 4
Flexing endurance - Dry 50.000 Cycles	UNI EN ISO 5402		No damage
Finish Adhesion - Dry	UNI EN ISO 11644	N/cm	> = 2
Colour fastness to artificial light - Exposition energy 16.000kj/sqm	UNI EN ISO 105 B02 (MET.5)	Blue Scale	> = 5
Smolder resistance, cigarette and match flame	CAL TB-117 (2013, Sec. 1) BS 5852: 1979, source 0-1 BS EN 1021-1-2:2006		Pass

Capture, Select, Luna / Gabriel

Gabriel A/S
Hjulmagervej 55
9000 Aalborg, DENMARK

DTI TEKSTIL
TEKNOLOGISK INSTITUT
GREGENSENVEJ
2630 TAASTRUP, DENMARK

**OEKO
TEX®**

Certificate

OEKO-TEX® STANDARD 100

Gabriel A/S

is granted the OEKO-TEX® STANDARD 100 certification
and the right to use the trademark.

SCOPE
Piece dyed, yarn dyed and fiber dyed upholstery and screen fabrics woven and non-woven of 100% wool, wool/polyamide 95-80/5-20%, wool/polyamide/anti-static fibres 93-94/4-5/2%, wool/linen/polyamide 58/35/7%, wool/polyester/cotton 38-86/11-40/7-22%, wool/polyester/polyamide 48-54/43-44/2-9%, wool/polyester 84/16%, wool/cotton 80/20%, cotton/polyester 80-86/14-20%; des. Luna Fleur WO/PA 90/10% with all-over embroidery.

PRODUCT CLASS
II (products with direct contact to skin) - Annex 4

SUPPORTING DOCUMENTS

- ✓ Test report : 174-48
- ✓ Declaration of conformity in accordance with EN ISO 17050-1 as required by OEKO-TEX®
- ✓ OEKO-TEX® Terms of Use (ToU)

This certificate 1076-17401 is valid until 30.06.2024.

PRODUKTKLASSE
IV (Ausstattungsmaterialien) - Annex 4

Weitere Compliance-Informationen (REACH, SVHC, POP, GB18401 etc.) finden Sie hier: [oeko-tex.com/en/faq](https://www.oeko-tex.com/en/faq).
Das Zertifikat basiert auf den zum Zeitpunkt der Zertifizierung gültigen Prüfmethoden und Anforderungen des OEKO-TEX® STANDARD 100.

Taastrup, 2023-05-30

Further compliance information (REACH, SVHC, POP, GB18401 etc.) can be found on [oeko-tex.com/en/faq](https://www.oeko-tex.com/en/faq).
The certificate is based on the test methods and requirements of the OEKO-TEX® STANDARD 100 that were in force at the time of evaluation.

ANETTE WERNER
Senior Consultant Textiles

ALLAN JENSEN
Consultant

OEKO-TEX® Service GmbH, Giefenstrasse 23, CH-8002 Zurich

Comfort / Gabriel

Gabriel A/S
Hjulmagervej 55
9000 Aalborg, DENMARK

DTI TEKSTIL
TEKNOLOGISK INSTITUT
GREGENSENVEJ
2630 TAASTRUP, DENMARK

**OEKO
TEX®**

Certificate

OEKO-TEX® STANDARD 100

Gabriel A/S

erhält die OEKO-TEX® STANDARD 100 Zertifizierung
und das Recht zur Nutzung der Marke.

SCOPE
Möbelbezugsstoff Artikel Comfort+ aus 88/12% Polyester/Polyurethan in mehreren Farben, mit anti-statische und flammhemmende Fasern (von OEKO-TEX® akzeptiert) auf der Rückseite und Antischmutzausrüstung auf der Vorderseite.

PRODUKTKLASSE
IV (Ausstattungsmaterialien) - Annex 4

Dieses Zertifikat 6234-4401 ist gültig bis 31.01.2024.

BEGLEITDOKUMENTE

- ✓ Testbericht : 44-31
- ✓ Konformitätserklärung gemäß EN ISO 17050-1 wie von OEKO-TEX® gefordert.
- ✓ OEKO-TEX® Allgemeine Nutzungsbedingungen (ANB)

Weitere Compliance-Informationen (REACH, SVHC, POP, GB18401 etc.) finden Sie hier: [oeko-tex.com/en/faq](https://www.oeko-tex.com/en/faq).
Das Zertifikat basiert auf den zum Zeitpunkt der Zertifizierung gültigen Prüfmethoden und Anforderungen des OEKO-TEX® STANDARD 100.

Taastrup, 2023-01-24

ANETTE WERNER
Senior Consultant Textiles

OEKO-TEX® Service GmbH, Giefenstrasse 23, CH-8002 Zurich

Never just sit.

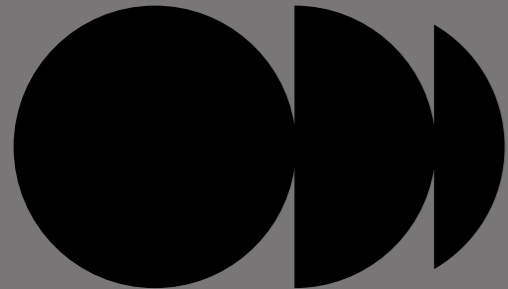

Aeris GmbH
Hans-Stießberger-Straße 2a
85540 Haar
Germany

Tel.: +49 (0) 89 - 900506 - 0
info@aeris.de
en.aeris.de